

STORAGE UNIT
COMFORT 2.1.2 MD
ТУМБА ДЛЯ ХРАНЕНИЯ

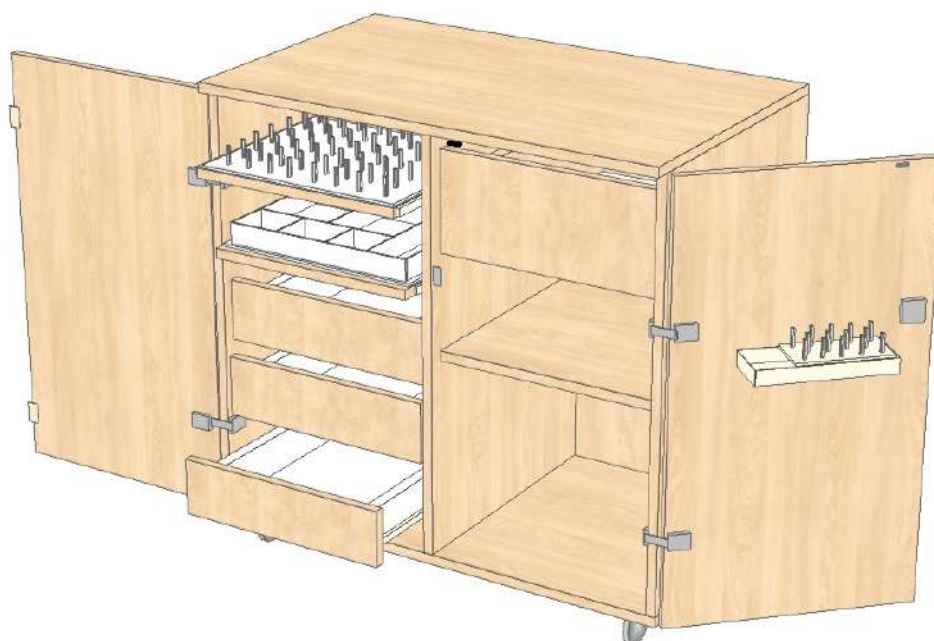

SYMBOLS

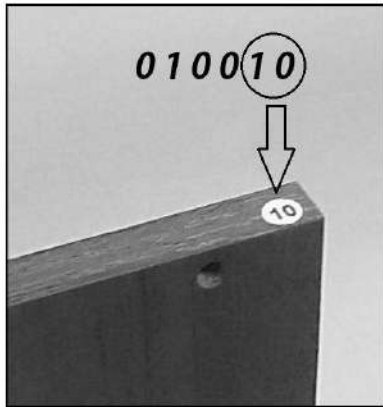

INDICATING MARK

ОБОЗНАЧЕНИЕ



ASSEMBLY & ADJUSTMENT

СБОРКА РЕГУЛИРОВКА

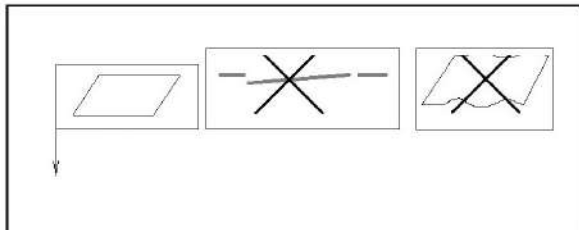

EVEN SURFACE











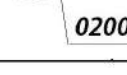

РОВНАЯ ПОВЕРХНОСТЬ

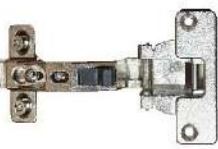





OPERATION

ЭКСПЛУАТАЦИЯ

010007	1x	010011	3x	010012	3x
010013	4x	010014	1x	010015	1x
010023	1x	010024	1x	010025	1x
010026	1x	010027	1x	010028	2x
010034	1x	010038	1x	010039	1x
010040	1x	010043	1x		

 020004 1x  020005 1x	2x  020006	1x  020011	1x  020012	4x 020018 
6x 020013 CR 	6x 020013 CL 	2x 020016 	020021 	
6x 020015 DL 	6x 020015 DR 	4x 020020 	4x 	

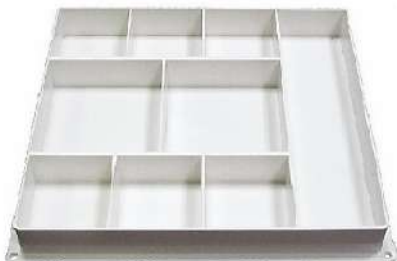
030001 26x  3 * 16	030002 56x  3,5 * 16	030003 18x  6,2 * 50	030033 2x  4,2 * 13	030006 4x  2,9 * 13	030008 4x  φ 4
030009 4x  M4 * 20	030011 18x  φ 15	030012 6x  φ 18	030013 6x  L 35	030014 6x  φ 15 h 12	
030015 14x  φ 8 * 30	030016 8x  φ 8 * 30	030017 8x  φ 15 h 10	030022 4x  M 10	030023 4x  φ 10	030031 4x  φ 10 s2,5

1x 050002 	1x 050004 	1x 050005 
1x 050003 		
S4 1x 		



S 4 *
S 5
S 10
S 12



6
030015
6X

010023

5
030013
6X

7 6X 030014 6X 030012

010025

010026

010024

010014

1
030002
12X
020013 CR
6X

010027

4
030011
8X
030003
8X

2 6X 030011
6X 03003

1
020013 CL
6X
030002
12X

3
4X 030022
4X 030031
4X 030023
4X 020021

4

* Входит в комплект стола.
Included into table set.

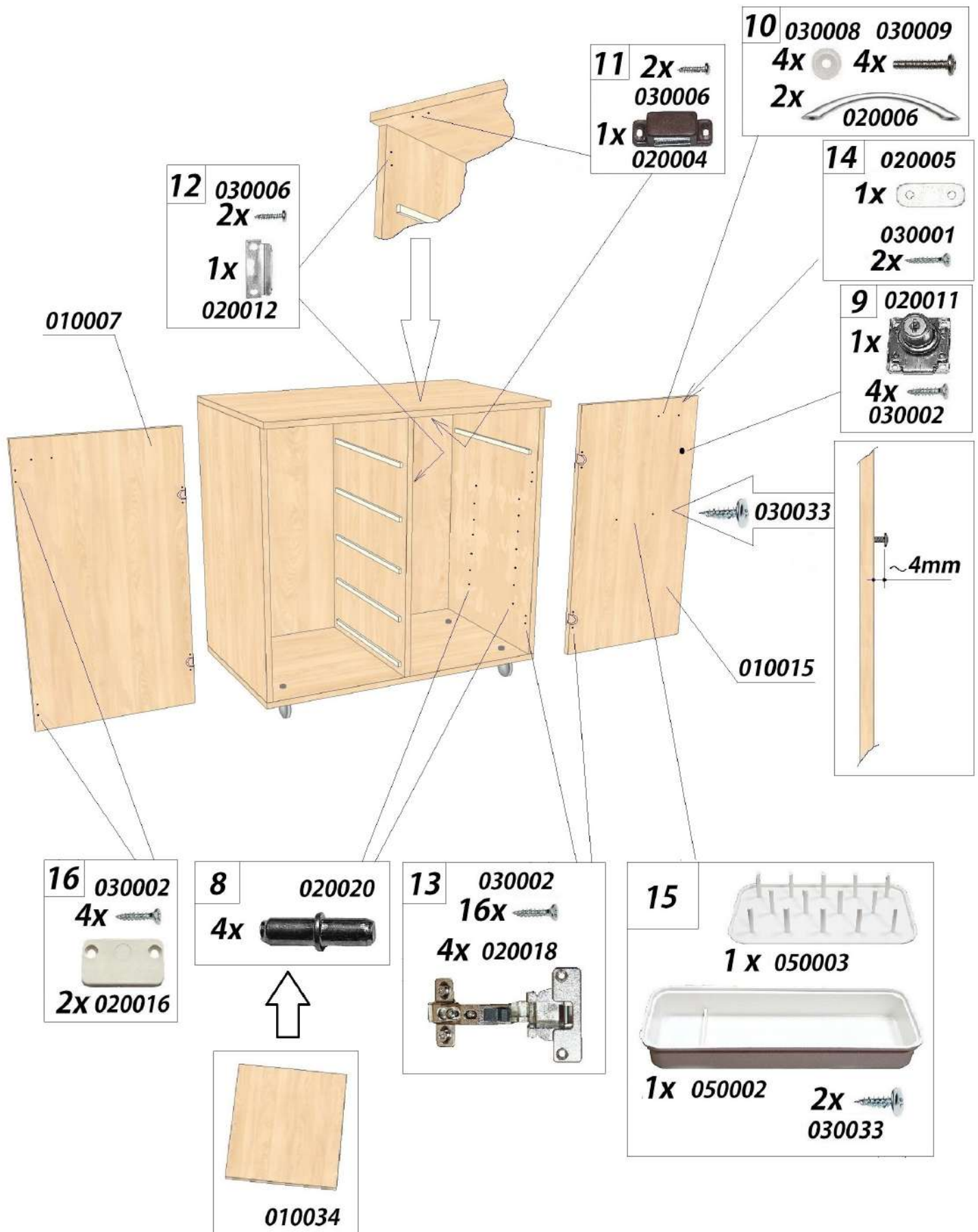

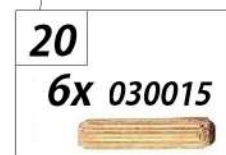
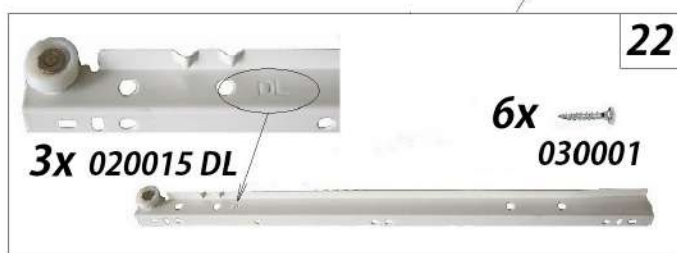
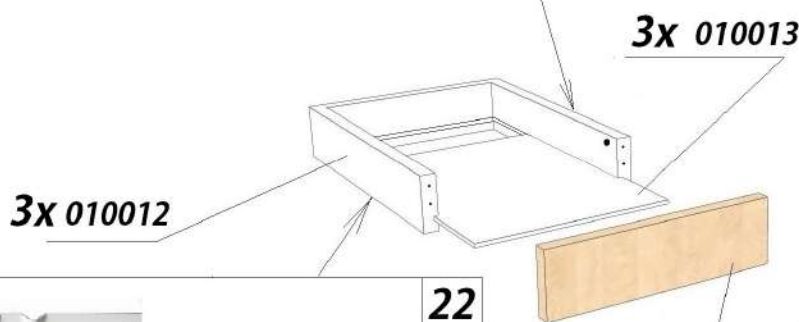
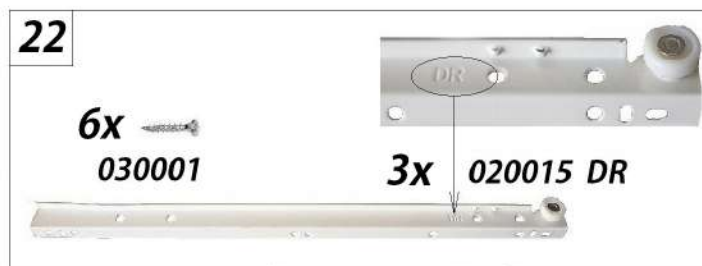
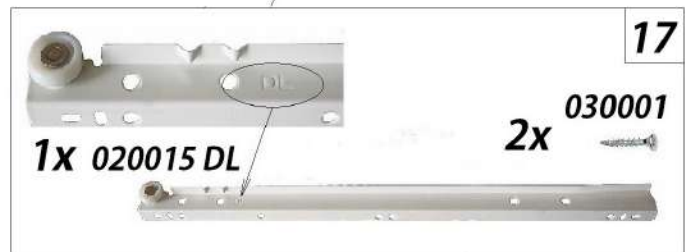
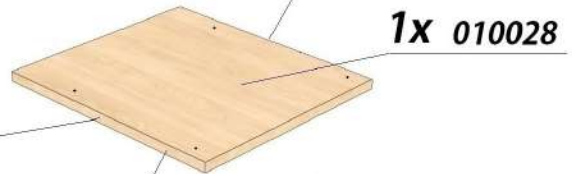
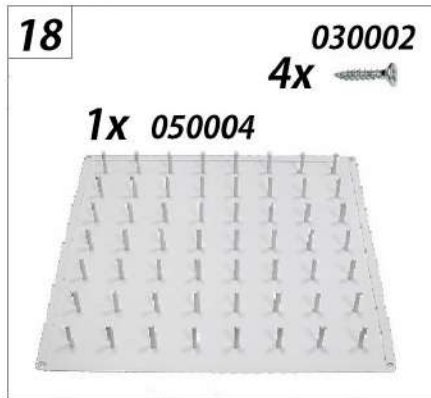
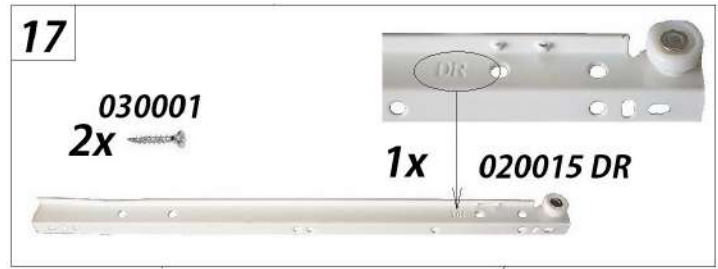
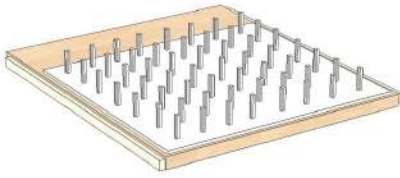

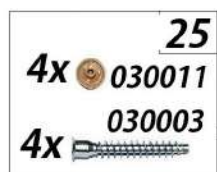
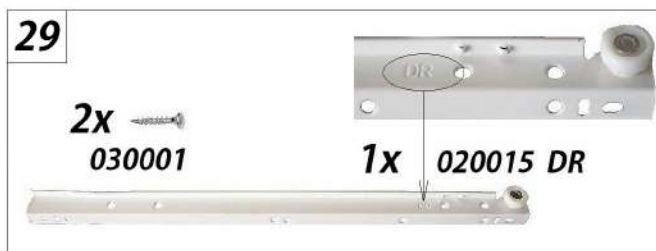
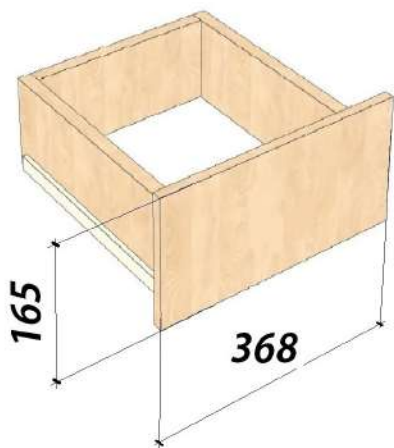
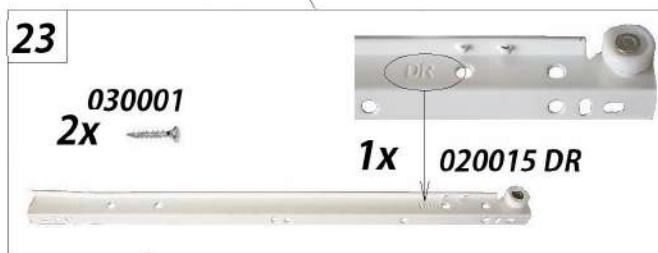
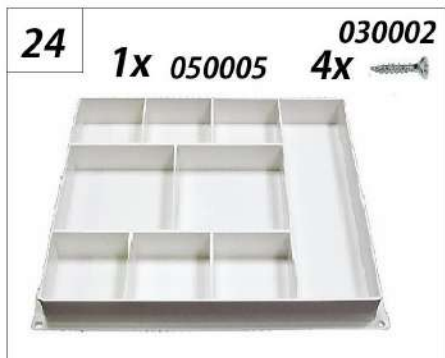
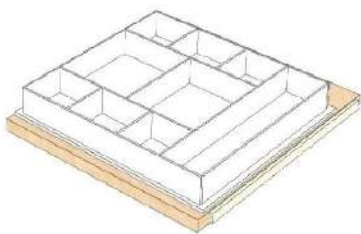

1x 010040

1x 010038



1x 010039

1x 010013

1x 010043

